



Speed Dome that comes with **Style!**

Stylish 10X interior speed dome camera

SPD-1000

## imagine Smart & Stylish Speed Surveillance

The SPD-1000 is an interior speed dome camera that is customized to suit indoor conditions and spaces while providing outstanding function. It provides a powerful monitoring of up to 100X zoom capability, with impeccable surveillance for all installation locations including : department stores, offices, office buildings and galleries.



**SAMSUNG TECHWIN**



# The ultimate interior speed dome camera is born !

## SPD-1000



## Smart & Stylish

- ↳ Up to **100X zoom** capability
- ↳ High-resolution image of **520TV lines**
- ↳ Ultra low light sensitivity of **0.005Lux**
- ↳ **ICR Day & Night** feature
  - 128 Preset settings, Digital flip
  - Privacy masking, Motion detection...

### Stylish **Designs** that suit Interiors

The SPD-1000 is an innovative speed dome camera that goes beyond just being a speed dome, placing a high priority on design, so that it can become a fashionable addition in different indoor environments. In addition to its small, compact sleek design and modern metallic silver color, the SPD-1000, equipped with Samsung Techwin's cutting-edge optical technology, provides smart video surveillance for any interior environment.



# Smart & Stylish at the same time!

## 10X Day & Night interior speed dome camera, **SPD-1000**



### Outstanding Accuracy with 10X Optical and 10X Digital Zoom

Equipped with a 10X optical A/F zoom lens, the SPD-1000 lets you zoom in with accurate focusing, and it provides up to 100X zoom capability with vivid images.



10X Optical Zoom



### Resolution of 520TVL lines for Images with More Detail

The SPD-1000, with its high-performance CCD image sensor and DSP chip, gives you a high resolution of 520TVL lines. The lines and colors of the subject are clear and vivid, making it easier to distinguish the subject being monitored.



Conventional Camera



SPD-1000



### Ultra Low Light Sensitivity of 0.0007Lux for Clearer Images at Night

The SPD-1000 ensures clear recognition and visualization of a subject even in dark or low light conditions. With an ultra low light sensitivity of 0.0007Lux and its effective SSNR noise reduction technology, it provides clear and vivid images, even in the dark, without any noise or after-imaging.

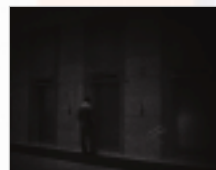

Conventional Camera



SPD-1000



### Day & Night (ICR type), Complete 24-hour Monitoring

The SPD-1000 produces optimum image quality at night by automatically removing the filters with its Day & Night feature (ICR type). It automatically switches either to vivid color images during the day or a high resolution of over 570TVL lines in black and white during the night.

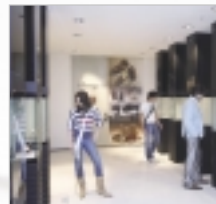

Day



Night

# Fashionable design and 100X high-definition image



Special dome for complete 24-hour monitoring, **SPD-1000**



## 128 Preset Settings for a Multiple Auto-surveillance Function

The SPD-1000 lets you specify up to 128 preset settings for automatic monitoring of a designated area. In particular, you can customize the monitoring to suit large areas by setting the conditions for different sectors with the OSD, or grouping up to 6 areas for effective surveillance.



## Motion Detection

The SPD-1000 provides the motion detection feature that automatically recognizes a subject being monitored and generates a warning message or alarm. Up to 4 detection areas can be specified.

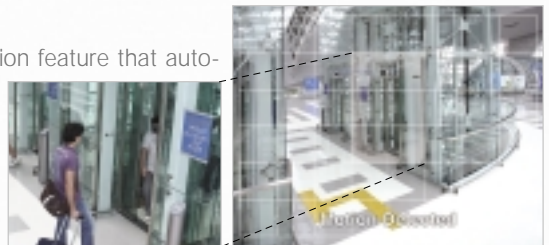

Motion Detected



## Privacy Masking for up to 4 zones

The SPD-1000's Privacy Masking feature can easily create a "mask" over areas that are sensitive in terms of surveillance ; up to 4 zones can be restricted.



## Digital Flip Function

If the subject in motion is moving behind the camera, the digital flip function allows an immediate automatic 180° turn for improved tracking.

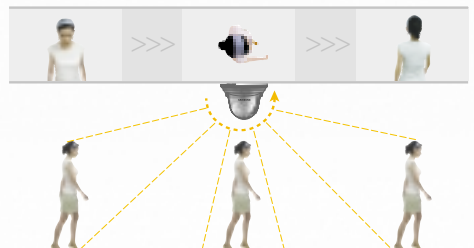

# Easy installation that comes with diverse functions

to ensure perfect stability and reliability

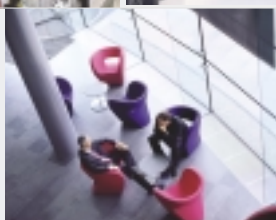
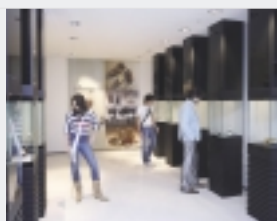

## Easy Installation

10X interior speed dome with smart and stylish monitoring, the SPD-1000 provides easy installation without complicated cabling for all locations, including : department stores, discount stores, museums, galleries and lobbies.



## Supports Various **Protocols** with Excellent Compatibility

The SPD-1000 is equipped with various protocols that can support a variety of applications, so that it can be used in any system environment.



## Wide Range **White Balance** for Optimum Color Images

The SPD-1000's wide range white balance feature automatically covers a color temperature range from 1,800°K to 10,500°K for optimum colors, even when used in poor conditions, for example in interior sodium lighting.



Normal



White Balance



## Convenient **OSD** Menu

Using the OSD menu that displays camera functions in characters on the screen, you can specify each camera function easily and conveniently.

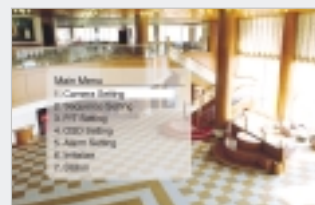

# High Resolution 10X Interior PTZ Dome Camera

# SPD-1000



## Specifications

Mode	SPD-1000N	SPD-1000P
Power Source	12V DC (±10%)	
Power Consumption	Max. 6W	
Image Pick-up Device	1/4" Interline Transfer CCD	
Total Pixels	811(H) x 508(V)	795(H) x 596(V)
Effective Pixels	768(H) x 494(V)	752(H) x 582(V)
Scanning System	2 : 1 Interlace 625 Lines / 60 Fields / 30 Frames	2 : 1 Interlace 625 Lines / 50 Fields / 25 Frames
Synchronization	Internal	
Scanning Frequency	15.734KHz(H) / 59.94Hz(V)	15.625KHz(H) / 50.00Hz(V)
Resolution	Color : 520TV lines (Min.) / B/W : 570TV lines (Min.)	
Video Output	1.0Vp-p / 75Ω (Video 0.714Vp-p, Sync 0.286Vp-p)	1.0Vp-p / 75Ω (Video 0.7Vp-p, Sync 0.3Vp-p)
S / N Ratio	More than 50dB (AGC off)	
Min. Illumination	0.7Lux@F1.8 (Normal color mode) 0.02Lux@F1.8 (B/W mode) 0.005Lux@F1.8 (Sens-up mode)	
Day & Night	Auto / Color / B/W (ICR filter change)	
Electronic Shutter Speed	Auto / Manual selectable (1/60 ~ 1/120,000)	
Slow-shutter	On (2X ~ 128X fields) / Off selectable	
White Balance	ATW / AWC / Manual selectable (1800°K ~ 10,500°K)	
Gain Control	Auto / Manual selectable	
OSD	On / Off selectable (English, Chinese, French, Germany, Spanish, Italy)	
Digital Zoom	2X ~ 10X (Total 100X zoom)	
Zoom Ratio	f3.8 ~ 38mm (10X)	
Multiple Protocols	PELCO-D, SEC, Panasonic, Vicon, Honeywell etc	
Serial Communication	RS-485	
Min. Focus Distance	1.5m	
Max. Zoom Speed	1.67sec	1.75sec
Pan Rotation Angle	350° Endless	
Pan Speed	140°/sec (64 step)	
Tilt Rotation Angle	-5° to 185°	
Tilt Speed	100°/sec (64 step)	
Privacy Function	On / Off Selectable (4 Programmable zone)	
Angle Field of View	H : 58.0°(Wide) to 2.2°(Tele) / V : 44.8°(Wide) to 1.68°(Tele)	
Preset	128 preset (Straight)	
Digital Flip	On / Off selectable	
Operating Temperature	-10°C ~ +50°C	
Operating Humidity	20% ~ 75% RH	
Dimensions	Ø140(W) x 134.8(H)mm	
Weight	0.8Kg	

## Dimensions

Unit : mm

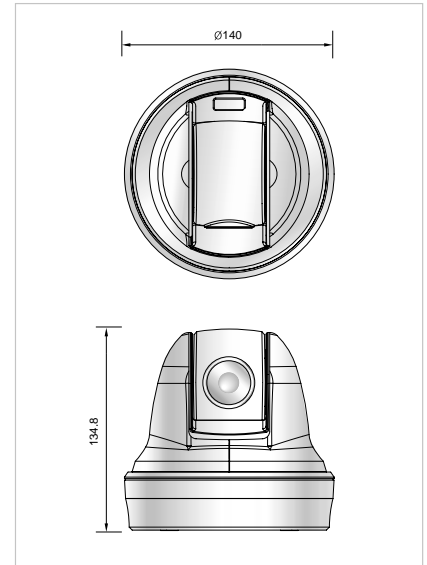

## Option

### Controller



SCC-3100A

### Accessories



STB-280PW

STB-230PW



STH-1000PI



The Eco mark represents Samsung Techwin's will to create environment-friendly products, and indicates that the product satisfies the EU RoHS Directive.

Design and specifications are subject to change without notice.



**SAMSUNG TECHWIN CO., LTD.**  
333-1, Sangdaewon 1-dong, Jungwon-gu,  
Seongnam-si, Gyeonggi-do Korea 462-807  
Tel : +82-31-730-8931-3 Fax : +82-31-730-8950  
www.samsungcctv.com

**SAMSUNG OPTO-ELECTRONICS UK, LTD.**  
Samsung House, 1000 Hillwood Drive,  
Hillswood Business Park Chertsey, Surrey KT16 0PS  
Tel : +44-1932-45-5308 Fax : +44-1932-45-5325

**TIANJIN SAMSUNG OPTO-ELECTRONICS CO., LTD.**  
7 Pingchang Rd., Nankai Dist. Tianjin 300190, P.R. China  
Tel : +86-22-2761-4724(33821) Fax : +86-22-2761-6514

DISTRIBUTED BY

